



Optic Control System

2 Wire Systems

Installation Reference

Franklin Fueling Systems • 3760 Marsh Rd. • Madison, WI 53718 USA

Tel: +1 608 838 8786 • 800 225 9787 • Fax: +1 608 838 6433 • www.franklinfueling.com

Installation Instructions for OCS Two-Wire Thermistor Compatible Probes

- Probe 1 is considered the front vehicle compartment.
- Pin 9 is designated for connection to the vehicle ground or ground proving device.
- Pin 10 is designated as the Common Return for all installed probes.
- Pins 1-8 are designated as Signal Wires from installed probes.
- To wire additional compartments, duplicate the wiring for the number of probes installed; remove and add jumper wires accordingly.
- All Common (White) wires are wired in parallel to Pin 10.
- All Signal (Black) wires are wired to their appropriate socket pin.
- Refer to the charts below for pin and wiring configurations.
- No Dummy Element required.

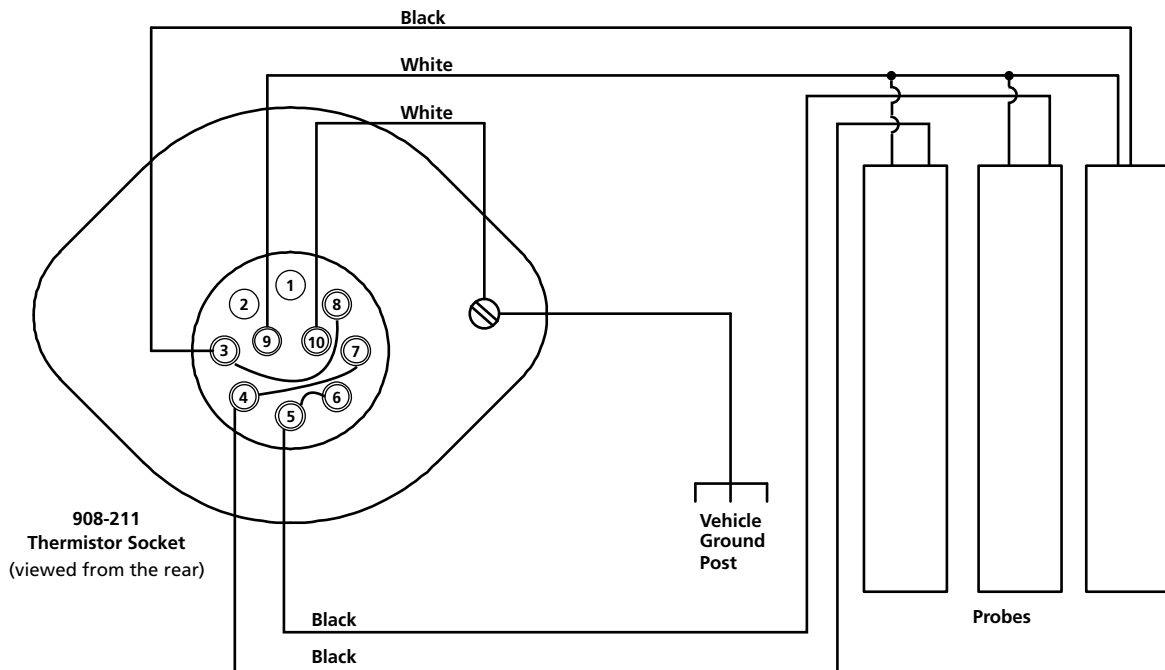

Pin Designations:	Pin 1	Compartment 7 OCS Probe Signal (Black) Wire *
	Pin 2	Compartment 8 OCS Probe Signal (Black) Wire *
	Pin 3	Compartment 1 OCS Probe Signal (Black) Wire
	Pin 4	Compartment 2 OCS Probe Signal (Black) Wire
	Pin 5	Compartment 3 OCS Probe Signal (Black) Wire
	Pin 6	Compartment 4 OCS Probe Signal (Black) Wire
	Pin 7	Compartment 5 OCS Probe Signal (Black) Wire
	Pin 8	Compartment 6 OCS Probe Signal (Black) Wire
	Pin 9	Vehicle Ground or Ground Proving Device
	Pin 10	Common (White) Wire for all probes

* Possible connection for additional compartments. Not required in all locations.

OCS Two-Wire (Thermistor Compatible) Wiring Solutions

ONE COMPARTMENT CONFIGURATION

- Pin 1 No Connection *
- Pin 2 No Connection *
- Pin 3 Compartment 1 OCS Probe Signal (Black) Wire
- Pin 4-8 Jumper to Pin 3
- Pin 9 Vehicle Ground Post
- Pin 10 Common (White) Wire for Probe 1

TWO COMPARTMENT CONFIGURATION

- Pin 1 No Connection *
- Pin 2 No Connection *
- Pin 3 Compartment 1 OCS Probe Signal (Black) Wire
- Pin 4 Compartment 2 OCS Probe Signal (Black) Wire
- Pin 5,6 Jumper to Pin 3
- Pin 7,8 Jumper to Pin 4
- Pin 9 Vehicle Ground Post
- Pin 10 Common (White) Wire for All Probes

THREE COMPARTMENT CONFIGURATION

- Pin 1 No Connection *
- Pin 2 No Connection *
- Pin 3 Compartment 1 OCS Probe Signal (Black) Wire
- Pin 4 Compartment 2 OCS Probe Signal (Black) Wire
- Pin 5 Compartment 3 OCS Probe Signal (Black) Wire
- Pin 6 Jumper to Pin 3
- Pin 7 Jumper to Pin 4
- Pin 8 Jumper to Pin 5
- Pin 9 Vehicle Ground Post
- Pin 10 Common (White) Wire for All Probes

FOUR COMPARTMENT CONFIGURATION

- Pin 1 No Connection *
- Pin 2 No Connection *
- Pin 3 Compartment 1 OCS Probe Signal (Black) Wire
- Pin 4 Compartment 2 OCS Probe Signal (Black) Wire
- Pin 5 Compartment 3 OCS Probe Signal (Black) Wire
- Pin 6 Compartment 4 OCS Probe Signal (Black) Wire
- Pin 7 Jumper to Pin 4
- Pin 8 Jumper to Pin 5
- Pin 9 Vehicle Ground Post
- Pin 10 Common (White) Wire for All Probes

FIVE COMPARTMENT CONFIGURATION

- Pin 1 No Connection *
- Pin 2 No Connection *
- Pin 3 Compartment 1 OCS Probe Signal (Black) Wire
- Pin 4 Compartment 2 OCS Probe Signal (Black) Wire
- Pin 5 Compartment 3 OCS Probe Signal (Black) Wire
- Pin 6 Compartment 4 OCS Probe Signal (Black) Wire
- Pin 7 Compartment 5 OCS Probe Signal (Black) Wire
- Pin 8 Jumper to Pin 5
- Pin 9 Vehicle Ground Post or Ground Proving Device
- Pin 10 Common (White) Wire for All OCS Probes

SIX COMPARTMENT CONFIGURATION

- Pin 1 No Connection *
- Pin 2 No Connection *
- Pin 3 Compartment 1 OCS Probe Signal (Black) Wire
- Pin 4 Compartment 2 OCS Probe Signal (Black) Wire
- Pin 5 Compartment 3 OCS Probe Signal (Black) Wire
- Pin 6 Compartment 4 OCS Probe Signal (Black) Wire
- Pin 7 Compartment 5 OCS Probe Signal (Black) Wire
- Pin 8 Compartment 6 OCS Probe Signal (Black) Wire
- Pin 9 Vehicle Ground Post or Ground Proving Device
- Pin 10 Common (White) Wire for All OCS Probes

* Pin 1 and Pin 2 are used in specific areas where more than six compartments are being loaded. Use Pin 1 for Compartment 7 and Pin 2 for Compartment 8

Two-Wire Diagrams

Vehicle Electrical
Power + 12-24VDC

TB1

I.S. GROUND
Negative Power
Input (Vehicle
Electrical Ground)

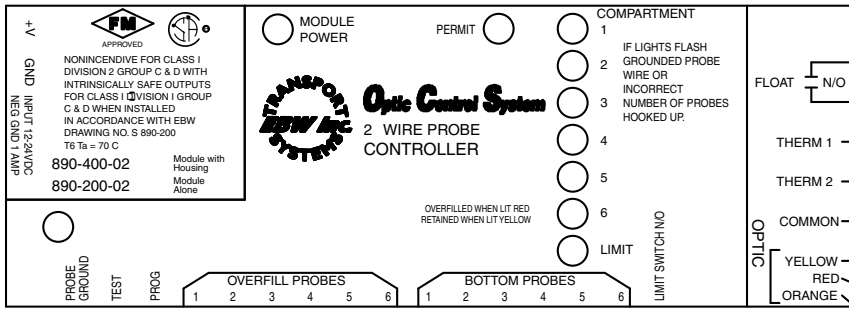

TO SOCKET

SEE SHEET 3 FOR TB3
NON-INCENDIVE FIELD
WIRING PARAMETERS

Float Format Output
(Conductivity When
Permissive)

Thermistor Format Output
(Negative Resistance
When Permissive)

4 Wire Optic Output Format
(Amplified Pulse Repeater
When Permissive)

TO SOCKET

TB2

TEST
BUTTON
N/O
908-168
(OPTIONAL)

SEE NOTES

Limit
Switch
N/O

Pressure
Switch
N/O

NOTE:
FOR OPTIC, THERMISTOR AND
THERMISTOR WITH DUMMY LOAD WIRING
SCHEMATIC, SEE PAGES 3, 4, AND 5.

NOTES:

1. Limit switch is EBW p/n 880-155-01
2. Use Hobbs p/n 76053 or equivalent.
3. Switches are optional. Wiring of limit switch and pressure switch is shown for switch options only.
4. Probe cable inductance limited to 11uH maximum.
5. Wiring between TB2 pin 16 and ground is non-incendive. Use only dry contacts wired in this circuit. Conduit is not required.

CLASS I - DIVISION 2 GROUP C AND D

CLASS I - DIVISION 1
GROUPS C AND D

890-110-LL
2 WIRE OVERFILL
PROBES

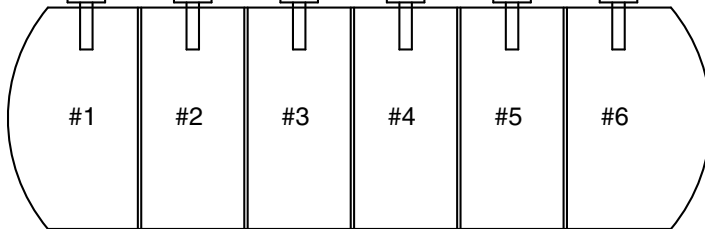

NOTE:
LESS THAN SIX PROBES MAY BE USED WITH
THE CONTROLLER.

Two-Wire Diagrams with Retain Probes

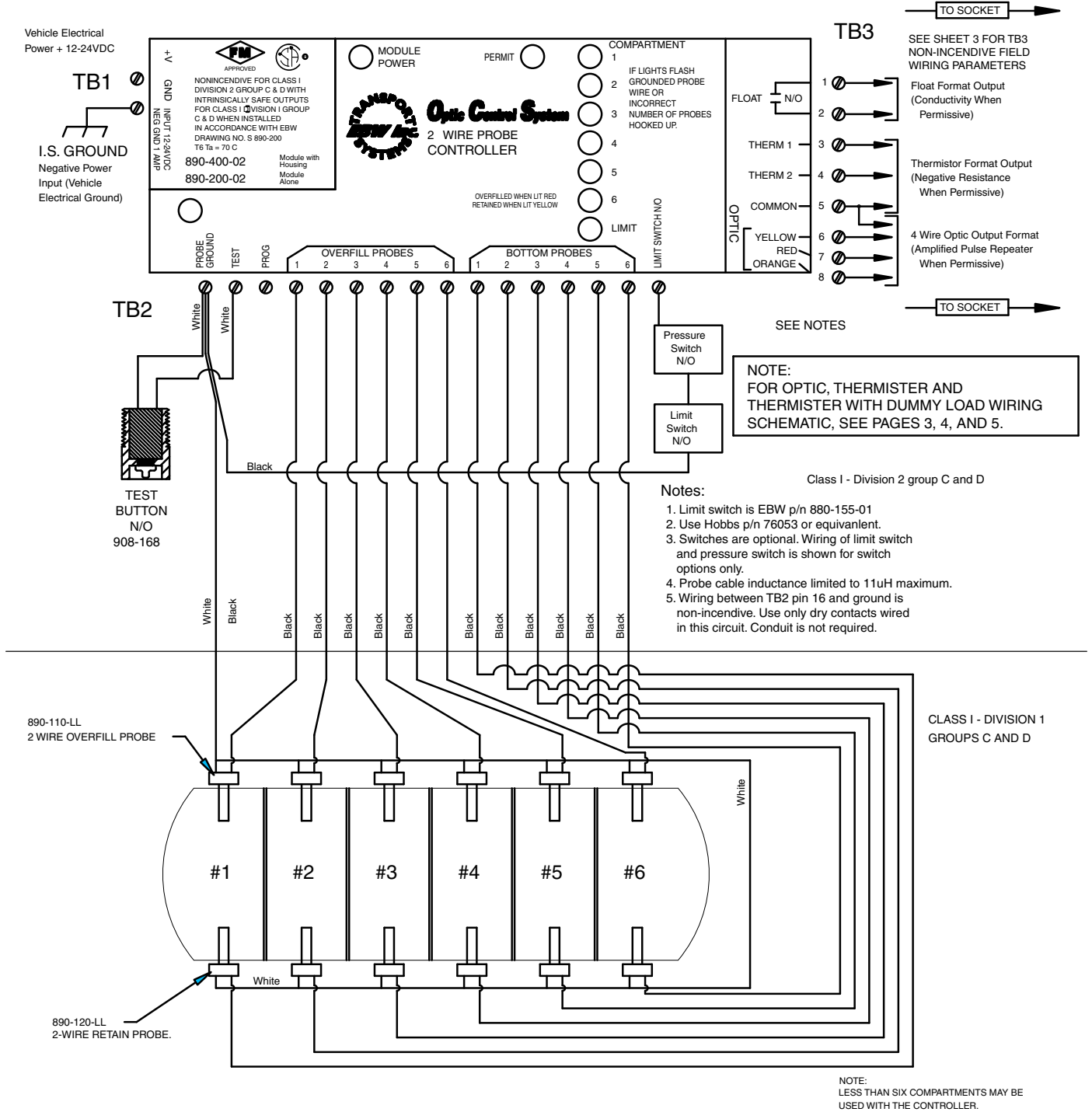

Two-Wire Diagrams

OPTIONAL WIRING SCHEMATIC
OPTIC SOCKET (W.O.G.A.)

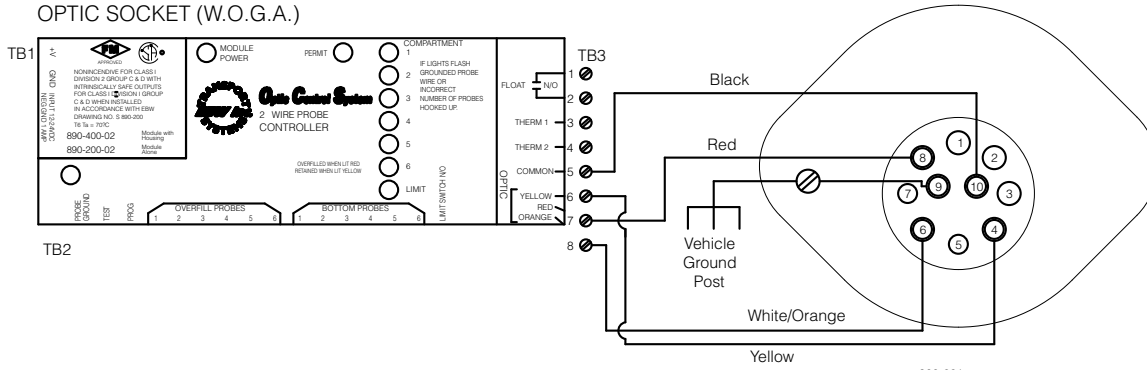

908-221
Optic Socket
(Viewed from the rear)

FOR FM APPROVAL ONLY
NON-INCENDIVE FIELD PARAMETERS FOR
TRANSLATOR OUTPUT TERMINALS (TB3)

TERMINAL NAME #	Vmax	I max	Ci	Li
Float 1 (1)	30	300ma	0	0
Float 2 (2)	30	300ma	0	0
Therm 1 (3)	30	300ma	0	0
Therm 2 (4)	30	300ma	0	0
Yellow (6)	30	300ma	0	0
Red (7)	30	300ma	0	0
Orange (8)	30	300ma	0	0

NOTE: Each terminal above measured to common (5) terminal

FOR CSA CERTIFICATION ONLY
TB3 TERMINALS PROVIDE NON-INCENDIVE
CIRCUITS FOR CLASS 1 DIV 2 WHEN
CONNECTED TO RTD, THERMOCOUPLE,
PASSIVE-RESISTIVE AND NON-ENERGY
STORING SWITCH DEVICES

OPTIONAL WIRING SCHEMATIC
THERMISTOR SOCKET

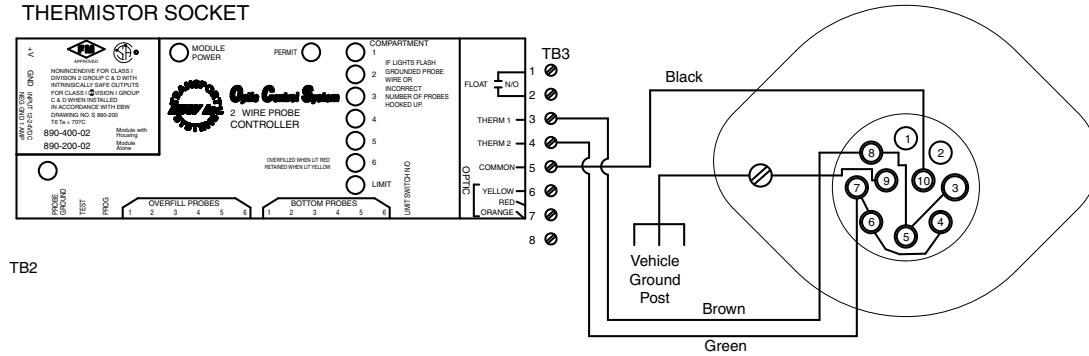

908-211
THERMISTOR SOCKET
(Viewed from the rear)

FOR FM APPROVAL ONLY
NON-INCENDIVE FIELD PARAMETERS FOR
TRANSLATOR OUTPUT TERMINALS (TB3)

TERMINAL NAME #	Vmax	I max	Ci	Li
Float 1 (1)	30	300ma	0	0
Float 2 (2)	30	300ma	0	0
Therm 1 (3)	30	300ma	0	0
Therm 2 (4)	30	300ma	0	0
Yellow (6)	30	300ma	0	0
Red (7)	30	300ma	0	0
Orange (8)	30	300ma	0	0

NOTE: Each terminal above measured to common (5) terminal

FOR CSA CERTIFICATION ONLY
TB3 TERMINALS PROVIDE NON-INCENDIVE
CIRCUITS FOR CLASS 1 DIV 2 WHEN
CONNECTED TO RTD, THERMOCOUPLE,
PASSIVE-RESISTIVE AND NON-ENERGY
STORING SWITCH DEVICES

Wiring Schematic For Thermistor System

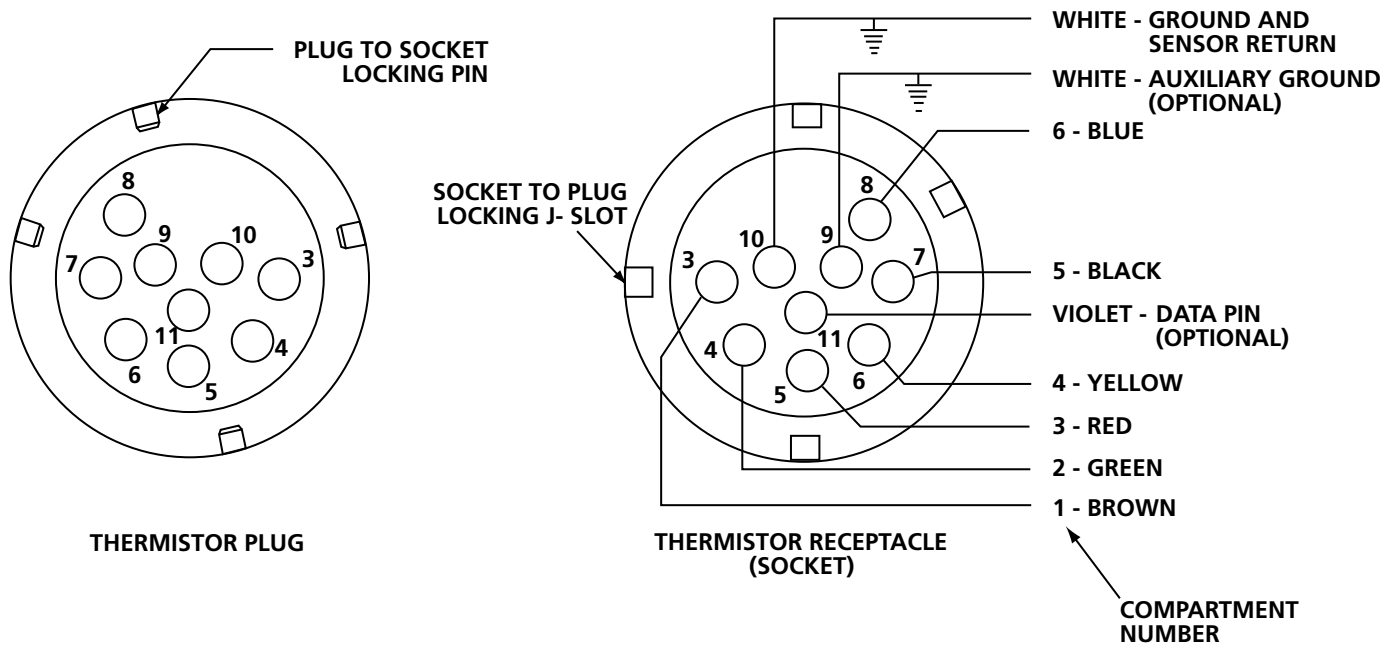

Wiring Color Coding

Color Coding for Thermistor System Wiring

PIN	DESCRIPTION OF LEAD	COLOR
3	To Probe in Compartment 1	Brown
4	To Probe in Compartment 2	Green
5	To Probe in Compartment 3	Red
6	To Probe in Compartment 4	Yellow
7	To Probe in Compartment 5	Black
8	To Probe in Compartment 6	Blue
9	Separate Auxiliary Ground (Optional)	White
10	Ground and Sensor Return	White
11	Data Pin (Optional)	Violet

Wiring Schematic For Optical System

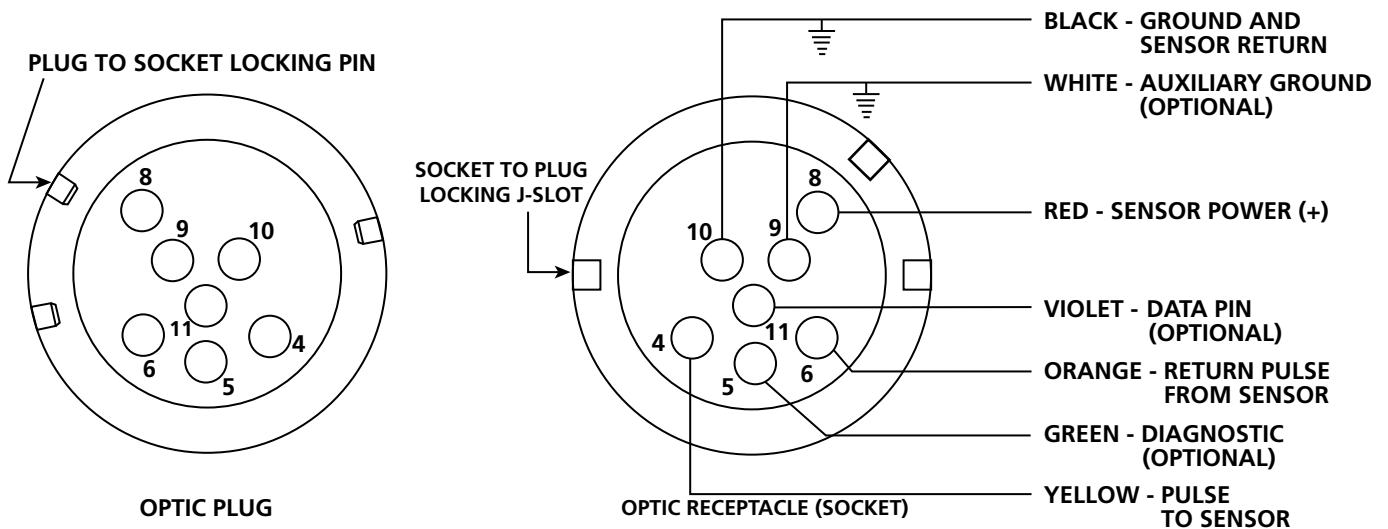

Wiring Color Coding

Color Coding for Optic System Wiring

PIN	DESCRIPTION OF LEAD	COLOR
4	Pulse to Sensor	Yellow
5	Sensor Diagnostic (Optional)	Green
6	Return Pulse from Sensor	Orange
8	Sensor Power (+)	Red
9	Separate Auxiliary Ground (Optional)	White
10	Ground and Sensor Return	Black
11	Data Pin (Optional)	Violet

Side View of Trailer Showing Need for Different Sensor Depths

Smaller compartment needs a longer sensor

Same 60 gallon outage required in each tank compartment

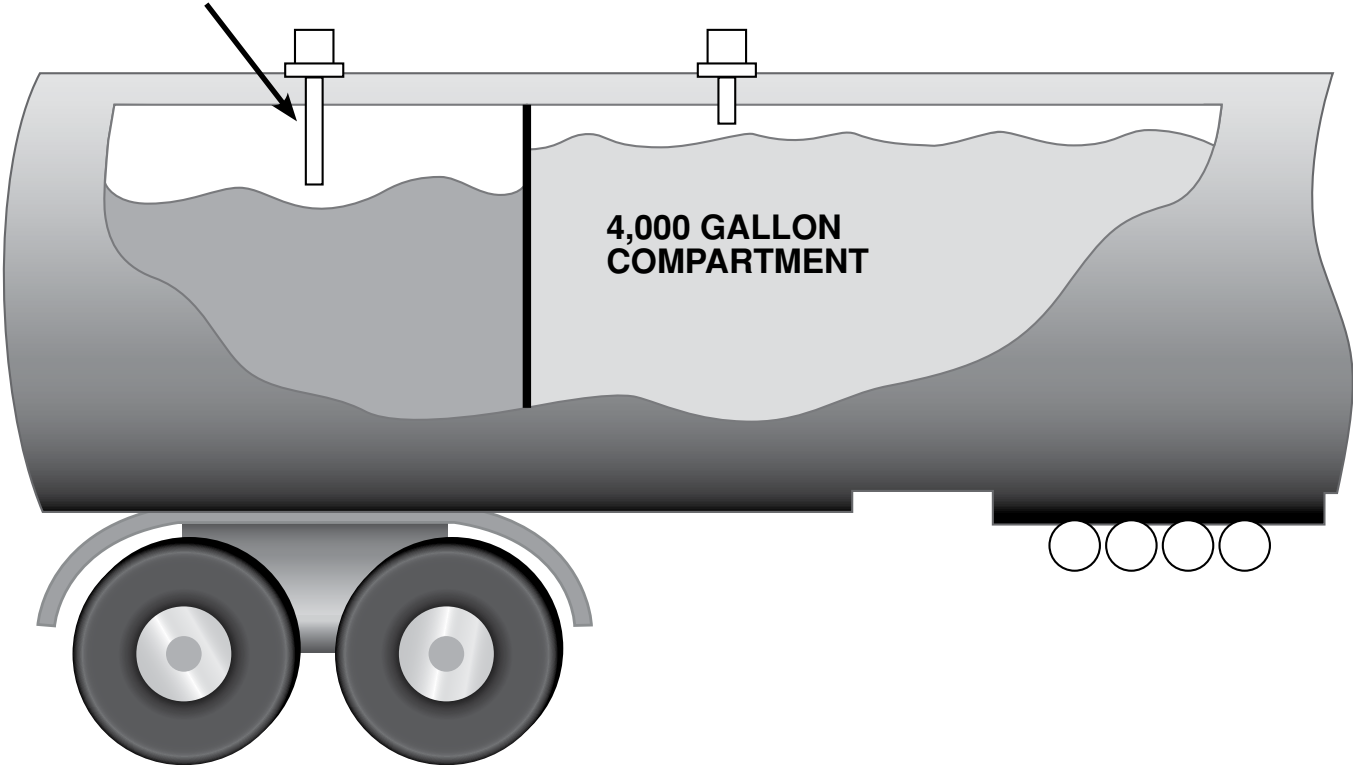

End View of Trailer Showing Various Levels and Two Methods of Mounting Sensors

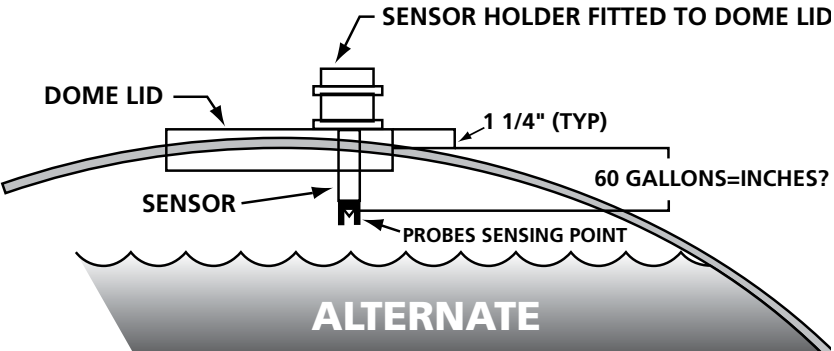
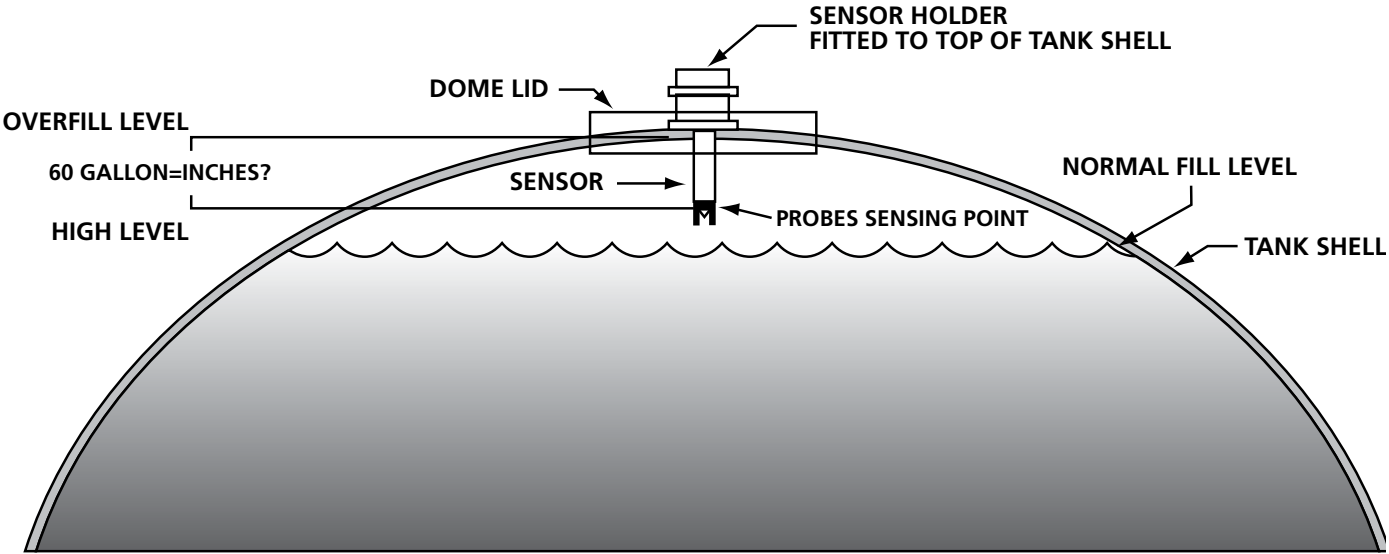

Electrical and Overfill Systems Cross Reference

OVERFILL CONTROLLERS		CIVACON	FLOTECH	SCULLY
890-400-02	OCS Controller 2-Wire	3100	FT103	8687
890-200-02	OCS Control Module Only 2-Wire			
STARFLEX		CIVACON	FLOTECH	SCULLY
908-428-01	Optic, Thermistor, Float			
908-423-01	Thermistor, Float			
908-433-01	Thermistor, Optic			
SOCKETS & CAPS		CIVACON	FLOTECH	SCULLY
908-110-01	Thermistor Conversion Kit			
908-119-01	Plastic Cap Only			
908-120-01	Optic Conversion Kit			
908-211-01	Thermistor Socket with Plastic Cap	4400	FT301	7720
908-221-01	Optic Socket with Plastic Cap	4100	FT300	7974
908-230-01	7-Pin Socket with Cap	4600	FT302	8116
908-231-01	7-Pin Socket Kit			
908-231-02	Socket Face			
908-232-01	Plate Only Thermistor			
OCS PROBES & HOLDERS		CIVACON	FLOTECH	SCULLY
890-110-01	2-Wire Optic Probe - 8 inch	1650	FT150	22389/09409
890-110-03	2-Wire Optic Probe - 16 inch	16505	FT150-12	31483
890-111-01	3-Wire Optic Probe - 8 Inch			
890-111-02	3-Wire Optic Probe - 12 Inch			
890-111-03	3-Wire Optic Probe - 16 Inch			
890-111-04	3-Wire Optic Probe - Flanged			
880-257-02	2-Wire Optic Probe w/ 908-263-01 Holder	1550	FT151	08501
890-257-01	3-Wire Optic Probe w/ 908-263-01 Holder			
908-208-01	Tall Probe Holder Cover			
908-213-01	Short Probe Holder Cover			
908-262-01	Probe Holder w/ 2" NPT Male Thread			
908-263-01	Probe Holder w/ Cast Lock Nut			
OCS INSTALLATION KITS & PARTS		CIVACON	FLOTECH	SCULLY
908-314-01	4 Comp. Kit (100' Cable, 22 Fittings)			
908-315-01	5 Comp. Kit (100' Cable, 26 Fittings)			
908-131-01	Watertight Fitting Only	2510	FT402	
908-132-06	100' - 7 Conductor Cable 18 AWG	2310	FT401	27382
OCS OVERFILL KITS		CIVACON	FLOTECH	SCULLY
890-160-02	2 Compartment Kit			8307
890-160-03	3 Compartment Kit			8308
890-160-04	4 Compartment Kit	2004	FT1004	8305
890-160-04	5 Compartment Kit	2005	FT1005	8306



Franklin Fueling Systems

3760 Marsh Road
Madison, WI 53718, U.S.A.
Tel: +1 608 838 8786
Tel: USA & Canada 1 800 225 9787
Tel: Mexico 001 800 738 7610
www.franklinfueling.com