



# FE PETRO<sup>®</sup>

## Franklin Fueling Systems

**3 PHASE SMART CONTROLLER**

**STP-SCIIC**

**STP-SCIIC 380-415 VAC, 50Hz, 240 Volt Coil**

# Installation and Owner's Manual



## Important Safety Messages

FE Petro equipment is designed to be used to pump volatile hydrocarbon liquids such as gasoline and diesel fuel. Installing or working on this equipment means working in an environment in which these highly flammable liquids are present. **This presents a risk of severe injury or death if these instructions and standard industry practices are not followed. Read and follow this entire instruction booklet before installing or working on this equipment.**

As you read these instructions, watch for the following safety symbols:

**Warning**  This symbol identifies a potentially hazardous situation which, if the instructions that follow it are not adhered to, could result in death or serious bodily injury.

**Caution**  This symbol identifies a potentially hazardous situation which, if the instructions that follow it are not adhered to, could result in serious property damage, including possible environmental contamination as a result of the leakage of fuel from the equipment.

---

**Warning**  **Follow all federal, state, and local laws governing the installation of this product and its associated systems. When no other regulations apply, follow NFPA codes 30, 30A, and 70 from the National Fire Protection Association. Failure to follow these codes could result in severe injury, death, serious property damage and/or environmental contamination.**

**Warning**  **Always disconnect both power supplies (240V Hook and the 415 input) before installing or servicing. Be sure to use proper lock and tag out techniques to ensure no power is applied accidentally. Failure to do so could result in severe injury or death.**

**Installer:** This instruction booklet **MUST** be left with the owner of the service station at which the equipment is being installed.

**Station Owner:** Retain these instructions for future use and provide them to persons servicing or removing this equipment.

**STP-SCIIC:** For 240 Volt hook signal; 380-415 Volt, 3 phase, 50Hz  $\frac{3}{4}$ ,  $1\frac{1}{2}$ , 3 and 5 Horsepower pumps.

## **INSTALLATION INSTRUCTIONS**

1. Install STP per applicable Installation and Owner's Manual.
2. Remove cover of STP-SCIIC and mount base to wall or other surface.
3. Connect input power of 380-415V for STP-SCIIC to L1, L2, L3 and Ground wire to terminals (see Figure 2). On High Capacity Pumps (3HP & 5HP) there is no need to connect the Thermal Overload wires (blue) coming from the pump as long as an STP-SCIIC is being used and is calibrated properly.
4. Connect dispenser hook signal or other equipment to terminals, 240V supply and return for STP-SCIIC.
5. Using an ohmmeter, confirm M1, M2 & M3 have continuity to pump. Also, make sure M1 to Ground, M2 to Ground, and M3 to Ground are not shorted.
6. Connect motor leads to M1, M2 and M3, and Ground wire to terminals.
7. Set SW1 Poles 4 and 5 for the motor Horsepower rating (see Table 3).
8. For Stand Alone installation, set (SW1) poles 1-3 per Table 2 (Factory Set). If installed as Master-Slave and/or Alternating Circuit go to "**Master-Slave/Alternating Circuit**" section.
9. Attach cover of controller to base. Then go to "**Calibration**" section to complete installation.

**Warning**  **Always replace the cover of the STP-SCIIC before applying power. Failure to do so could result in severe injury or death.**

## **CALIBRATION**

**Note:** It is recommended to calibrate all manifolded Master and Slave controllers at the same time.

1. Turn on power supply to the STP-SCIIC. The green light indicator will come on steady, the red light indicator will flash 8 times and an audible alarm will sound, thus indicating the controller is Uncalibrated.

**Note:** The audible alarm will sound each time the red light indicator flashes. During the calibration process, do not silence the alarm. Once the calibration process has been completed, an alarm can be silenced when an abnormal condition is present by briefly depressing the push button. See "Troubleshooting Guide" for details.

2. Press and hold the push button on the bottom of the box until all three light indicators blink alternately. This will take approximately 10 seconds. At this point the push-button should be released.
3. The handle on the dispenser should then be lifted to turn the pump on (for more than 16 seconds). After 16 seconds the controller will take a "snapshot" of the voltage, current and power. The three lights will quit alternating and only the green light should remain flashing. This will indicate the calibration has been completed and the dispenser handle can then be turned off. If the controller(s) will not calibrate, see the "**Troubleshooting Guide**" section.

### **Calibration Tips:**

The "snapshot" values will be used as the nominal values. The calibration process will be aborted if not completed within 10 minutes or if the push button is depressed during calibration. The calibration must be done at zero flow. If an electronic line leak detector is being used, it is important that the STP-SCIIC be in the calibration mode (all three lights flashing alternately) before the dispenser handle is turned on. Otherwise, the STP-SCIIC will not turn on and the line leak detector will likely detect a fault. If the line leak detector shows a fault, it will not provide a dispenser hook signal to the STP-SCIIC and it will not be possible to calibrate the STP-SCIIC until the line leak detector is reset.

**Note:** All STP-SCIICs must be calibrated prior to operation.

**Note:** All three indicator lights will flash alternately in calibration mode.

**Note:** When calibrating system and dispensers that are blenders, both STP-SCIICs must be calibrated simultaneously by selecting the mid-grade at the dispenser.

**Note:** The calibration data is retained in non-volatile memory (i.e. it is saved in the event of power loss to the controller).

## **MASTER-SLAVE/ALTERNATING CIRCUIT**

**Note:** RS 485 Connection is only required if Master-Slave or Alternating Circuit operation is desired.

**Note:** Be sure L1, L2, L3; M1, M2, M3 and Grounds are installed at each STP-SCIIC.

The Master-Slave feature allows the master to turn on additional STP's when the first STP operating needs help due to loading (flow rate) or an abnormal condition exists. The Alternating Circuit (AC) feature continuously alternates the lead pump, thus turning on a different STP each time all dispensers are shut off and at least one dispenser is turned back on.

1. (Fig. 2) Connect RS 485 (+, G, & -) to terminals. Connect drain wire of shielded cable to Ground (G) at one end only. Wire per NFPA 30A and NFPA 70. For the signal wires, use 18 AWG 3 conductor cable (300V min.), with conductors twisted and within a common jacket. Cut wires to length so that there is no excess wire touching circuit board components.
2. (Fig. 2) Connect hook between STP-SCIIC's.
3. Set Master-Slave and Alternating Circuit features on (SW1) poles 1-3 per Table 2.
4. Set (SW1) poles 6-8 per "Table 1". The address must be set for each STP-SCIIC.
5. Attach cover of controller to base. Then go to "**Calibration**" section to complete installation.

**Warning**  **Always replace the cover of the STP-SCIIC before applying power. Failure to do so could result in severe injury or death.**

**Note:** There can only be one Master in a system and up to 7 slaves.

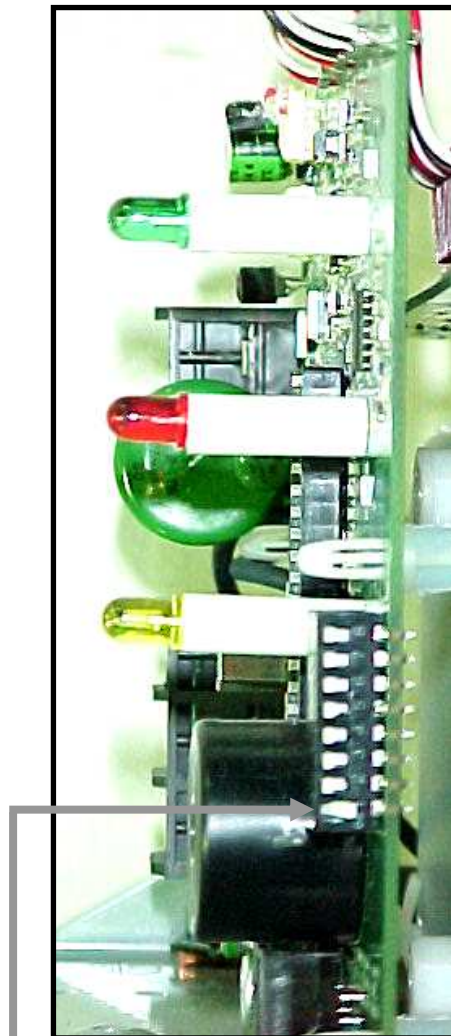

SW1-Pole 1 in the **ON** position = selected

**Figure 1**

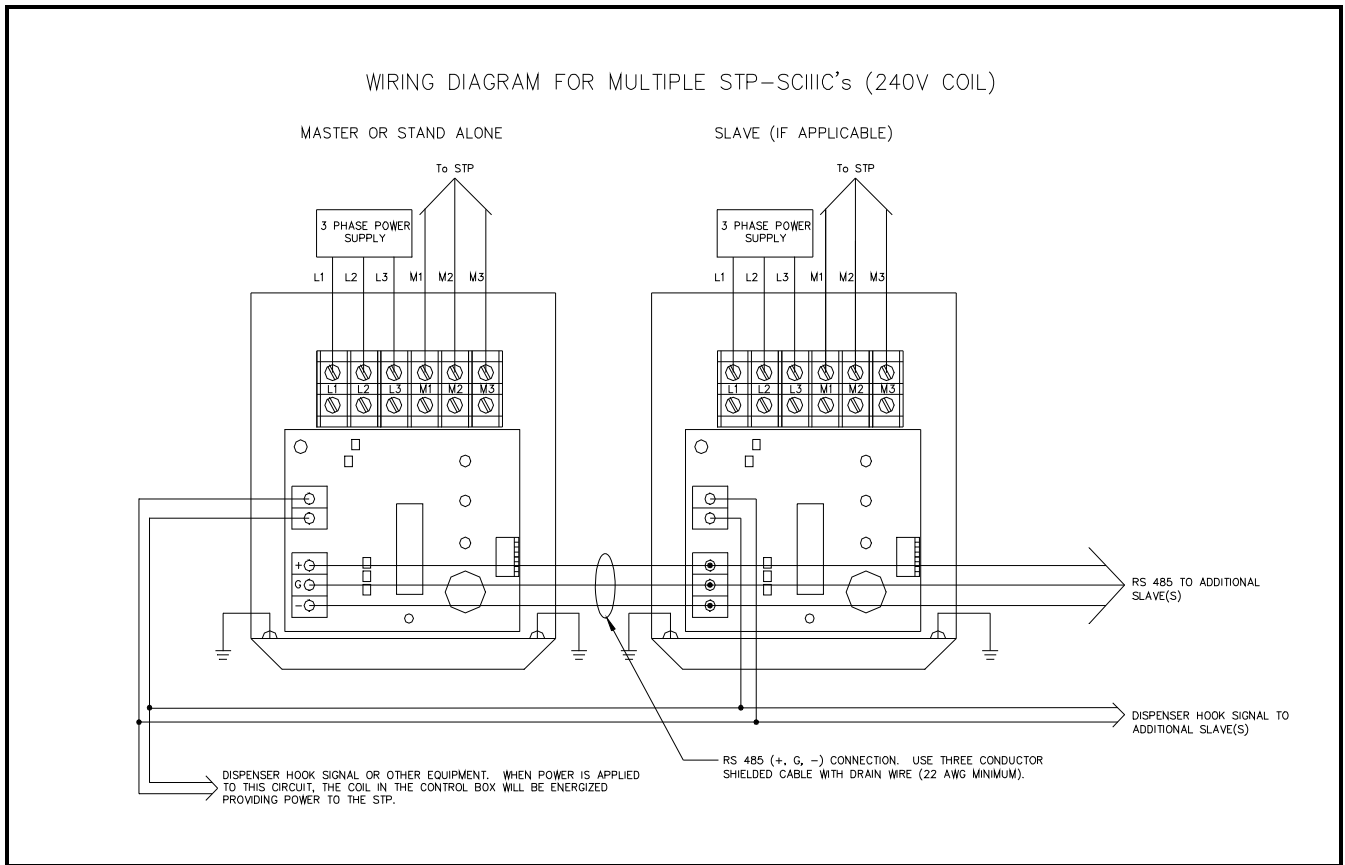

**Figure 2**

**Address Selection**

<b>Address</b>	<b>Pos-7</b>	<b>Pos-8</b>
Master-0	Off	Off
Slave-1	Off	On
Slave-2	On	Off
Slave-3	On	On
Slave-4	Off	Off
Slave-5	Off	On
Slave-6	On	Off
Slave-7	On	On

**Table 1**

Pole	Stand Alone	**Master-Slave Only		**Master-Slave/AC		**AC Only	
		Master	Slave(s)	Master	Slave(s)	Master	Slave(s)
1	On	Master	Slave(s)	Master	Slave(s)	Master	Slave(s)
		Off	Off	Off	Off	Off	Off
2	Off	Master	Slave(s)	Master	Slave(s)	Master	Slave(s)
		On	Off	On	Off	Off	Off
3	Off	Master	Slave(s)	Master	Slave(s)	Master	Slave(s)
		Off	Off	On	Off	On	Off
4-5	See Table 3	See Table 3		See Table 3		See Table 3	
6	See Table 4	See Table 4		See Table 4		See Table 4	
7-8	N/A	See Table 1		See Table 1		See Table 1	

\*\*See "Master-Slave/Alternating Circuit" section for definition, AC= Alternating Circuit

**Table 2**

**Motor Horsepower Rating Selection Table**

Motor Horsepower Rating	Pole 4	Pole 5
¼ HP	Off	Off
1.5 HP	Off	On
3 HP	On	Off
5 HP	On	On

**Table 3**

**Fault Readout Selection Table**

Pole 6 Setting	Description
Off	Normal Operation
On	Displays the last 5 abnormal conditions the controller encountered. With this mode selected, the controller will display the last 5 abnormal conditions it encountered. The controller will beep once and then the red LED will flash the most recent abnormal condition. It will then beep twice and the red LED will flash the second to last abnormal condition. The controller will follow this sequence through 5 beeps and then repeat the sequence. It will continue to repeat the sequence while in this mode. If there is less than 5 abnormal conditions the controller will continue the beep sequence but the red LED will not flash after the beep.

**Table 4**

# WIRING DIAGRAM 1

## WIRING DIAGRAM FOR SUBMERGED TURBINE PUMPS WITH 240 VOLT COIL LINE STARTER CIRCUIT MODEL STP-SCIII THREE PHASE MOTOR CONTROL PANEL

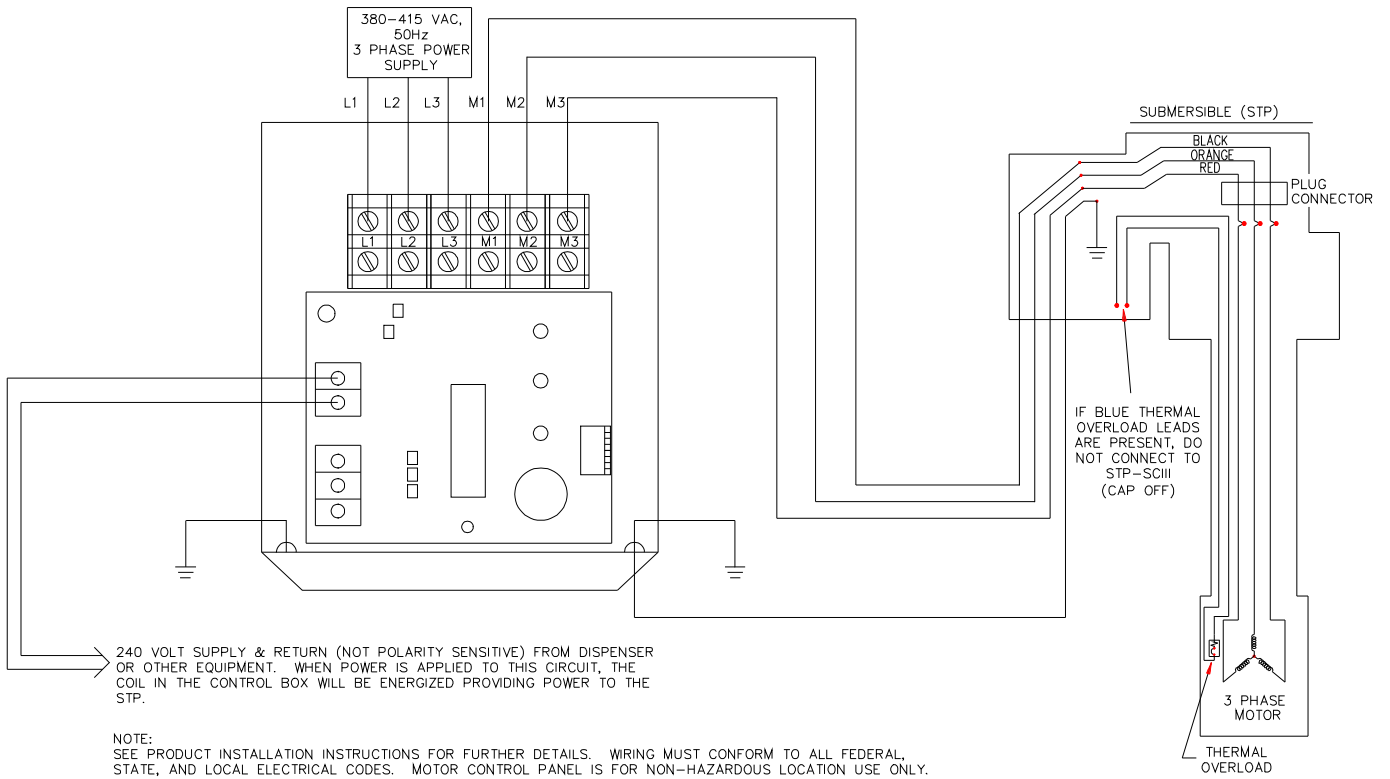

## TROUBLESHOOTING GUIDE

To aid field service personnel the STP-SCIIC is equipped with a microprocessor control that makes it possible for the unit to diagnose abnormal operating conditions, and communicate them via the LEDs and an audible alarm. The following is a definition of all operation and abnormal operating codes.

### RESETTING THE CONTROLLER

To reset the controller from an abnormal condition depress the push-button (reset button) on the bottom of the control box and hold it in until the lights on the front panel go out (approximately 3 seconds).

### DISABLING THE AUDIBLE ALARM

To disable the audible alarm, depress and release the push button. **Note:** This only stops the audible alarm and does not clear the fault code.

**Warning**  **Always disconnect all power sources to the STP-SCIIC prior to removing the cover and replace cover prior to applying power. Failure to do so could result in serious injury or death.**

1. **Green light on steady** - Power (380-415V) is applied to the STP-SCIIC.
2. **Green light flashing** - Pump Motor Assembly (PMA) is running.

**Note:** If the green light stays steady, even when a dispenser is energized, double check dispensers signal terminal on STP-SCIIC. Verify there is 240V for the STP-SCIIC between the two terminals for the hook (See Wiring Diagram, p.7). If the green light remains steady, power is supplied to the "HOOK" connector, and all switch settings are correct, call FE Petro Technical Service for assistance.

**Note:** If the green light constantly flashes, even when all the dispensers are turned off, there may be some power still applied to the STP-SCIIC Hook Connector. If this condition exists call FE Petro Technical Service for assistance.

3. **No lights illuminated** – Verify L1 and L3 are properly connected to the L1 and L3 terminals on the STP-SCIIC
4. **Red light flashing/Audible alarm** - Abnormal condition, see below:

<i>Flashes/Beeps</i>	<i>Condition</i>	<i>Potential Causes</i>	<i>Proposed Action</i>
<b>1</b>	Dry Run (Under-load)	Low fuel level in the storage tank or obstruction to motor intake.	<ol style="list-style-type: none"> <li>1. Check fuel level in storage tank; schedule fuel delivery, when delivery is complete and fuel level is above PMA end bell, depress and hold in push button until all lights go out (approximately 3 seconds).</li> <li>2. If fuel levels are within an acceptable range, check motor for an obstruction such as a rag.</li> <li>3. If condition is still present, verify the switch settings for motor horsepower rating are correct. If they are not correct, change them and recalibrate the controller.</li> </ol>
<b>2</b>	Under Voltage	Voltage fluctuations or low input voltage.	<ol style="list-style-type: none"> <li>1. Push reset button and hold in for three seconds.</li> <li>2. If condition is corrected, check for proper operation of system; if operating correctly do not continue to next step. If condition is still present continue to next step.</li> <li>3. Disconnect Input Voltage at the load center. Remove cover from enclosure. Re-apply input power. Use AC voltmeter to verify incoming voltage is within the 190-250VAC for STP-SCIII or 340-420 VAC for STP-SCIIC acceptable range. If voltage is not within this range, contact an electrician to correct problem. If voltage is within acceptable range and you still get "Under Voltage" condition after reset, recalibrate controller per "<b>Calibration</b>" section.</li> </ol>

Flashes/Beeps	Condition	Potential Causes	Proposed Action
<p style="text-align: center;"><b>3</b></p> <p>(Continued on next page)</p>	<p>Locked Rotor/Overload</p>	<p>Foreign material in PMA or rotor within motor is locked up.</p>	<ol style="list-style-type: none"> <li>1. Push reset button and hold in for three seconds.</li> <li>2. If condition is corrected, check for proper operation of system; if operating correctly do not continue to next step. If condition is still present continue to next step.</li> </ol> <p><b>PMA Replacement/Inspection for 3/4 &amp; 1.5 hp pumps</b></p> <ol style="list-style-type: none"> <li>3. Disconnect input voltage at load center, lock and tag circuit breakers.</li> <li>4. (See PMA Replacement Instructions P/N 400289002) Disengage the 3/4" securing bolt of the electrical connector and swing out of the way. Remove two 9/16" bolts from extractable portion of the manifold.</li> <li>5. Pull extractable part of the pump.</li> </ol> <p><b>Note:</b> Pump Motor Assembly shell can be damaged by blows from hard surfaces, use care in removing.</p> <ol style="list-style-type: none"> <li>6. Remove black end cap from PMA and attempt to spin rotor with a 1/4" Allen wrench to determine if there's any binding. If rotor does not spin freely and/or there is physical damage (note this on a warranty claim form for FE Petro use), proceed with the next step. If no binding or physical damage to PMA, and it is a new installation, reinstall extractable.</li> </ol> <p><b>Note:</b> PMA can have a locked rotor during startups if it has been exposed to a corrosive environment, such as a ballasted tank. Turn on power to the STP-SCIII unit and verify correct system operation. If condition is corrected, do not continue to next step. If condition is still present, remove the extractable (repeat steps 3, 4, &amp; 5) and continue to next step.</p> <ol style="list-style-type: none"> <li>7. Remove four 5/16" cap screws that connect the PMA and remove the PMA from the motor discharge head.</li> </ol> <p><b>Note:</b> Prior to mounting a new PMA, check lead assembly (wires inside the extractable portion to PMA) for shorted wires which may have caused the condition.</p> <ol style="list-style-type: none"> <li>8. Replace with new PMA.</li> </ol> <p><b>Note:</b> Pump motor shell can be damaged by blows from hard surfaces, use care in replacing.</p> <ol style="list-style-type: none"> <li>9. Re-install extractable and secure by following reverse order of disassembly.</li> <li>10. Turn on power to the STP-SCIII unit and verify correct system operation.</li> </ol> <p><b>PMA replacement/inspection for 3 &amp; 5 hp pumps</b></p> <ol style="list-style-type: none"> <li>1. Disconnect input voltage at load center. Lock and tag circuit breakers.</li> <li>2. Pull extractable portion of the pump.</li> <li>3. Remove 4 socket head cap screws and 4 lock washers securing PMA to STP.</li> <li>4. Place 2 push rods and 2 headless set screws (furnished with replacement PMA) in holes opposite each other.</li> <li>5. Turn set screws clockwise until pressure is felt, then alternately turn each screw until PMA is free of connector housing.</li> <li>6. Install 2 new O rings and 4 rubber washers. Attach</li> </ol>

<b>Flashes/Beeps</b>	<b>Condition</b>	<b>Potential Causes</b>	<b>Proposed Action</b>
<b>3</b> Continued			<p>new PMA with 4 socket head cap screws and 4 lock washers; draw the PMA tight to the connector housing with screws.</p> <p><b>Caution</b>  <b>Key on lead assembly plug connector must line up into keyway of connector housing for proper mating of PMA receptacle.</b></p>
<b>4</b>	Open Circuit Or Locked Rotor W/Thermal Overload Open Or Relay Fault	Connection broken from STP-SCIII to PMA or Relay Failure	<ol style="list-style-type: none"> <li>1. Wait 5 minutes before depressing the push button. This will allow the thermal overload to reset if a locked rotor has occurred on the ¾ or 1.5 hp pumps.</li> <li>2. If condition is corrected, check for proper operation of system; if operating correctly do not continue to the next step.</li> <li>3. Disconnect power at load center, lock and tag out circuit breakers.</li> <li>4. Remove cover from the STP-SCIII.</li> <li>5. Remove the three motor control outputs (M1, M2 &amp; M3) from the STP-SCIII unit. Using an ohmmeter, measure the winding resistance between all three leads (M1 to M2, M1 to M3 and M2 to M3) and compare the values with the values found in the STP/IST Installation Manual, High Capacity Installation Manual or TB004.</li> <li>6. Troubleshoot the wiring to determine the cause of the open circuit between the STP-SCIII and the PMA.</li> </ol> <p><b>Note:</b> Always lockout and tagout power sources before servicing.</p> <ol style="list-style-type: none"> <li>7. If the problem has been corrected, put the cover back on the enclosure, turn on power to the STP-SCIII and verify system is operating correctly.</li> <li>8. Inspect the 3-phase relay. It may be stuck open or damaged. Replace the relay.</li> </ol>
<b>8</b>	Uncalibrated	New Installation	<ol style="list-style-type: none"> <li>1. Calibrate per <b>“Calibration”</b> section.</li> <li>2. If condition is corrected, check for proper operation of system; if operating correctly do not continue to next step. If condition is still present continue to next step.</li> <li>3. Check the following: <ul style="list-style-type: none"> <li>• Calibration is done at no flow (dead head).</li> <li>• Hook signal is applied within 10 min. when set in calibration mode.</li> <li>• No open circuits between controller and motor.</li> <li>• Lines have been purged.</li> <li>• Proper Motor Horsepower Rating has been selected. (See Table 3).</li> <li>• Push button has not been depressed to silence the alarm during calibration process.</li> </ul> </li> <li>4. If the above conditions are correct, contact FE Petro Technical Support for assistance.</li> </ol>
<b>9</b>	Extended Run	Continuous Hook Signal applied for more than 60 min. without pumping product	<ol style="list-style-type: none"> <li>1. Disconnect power at load centers, lock and tag circuit breakers. Remove cover from enclosure.</li> <li>2. Check voltage across hook terminal with all dispenser handles off. There should be no voltage applied. If voltage is present, contact an electrician to correct the problem. If no voltage is present, contact FE Petro Technical Support for assistance.</li> <li>3. After the problem has been corrected, put cover</li> </ol>

<i>Flashes/Beeps</i>	<i>Condition</i>	<i>Potential Causes</i>	<i>Proposed Action</i>
			back on enclosure, turn on power to the STP-SCIII and verify system is operating correctly.
<b>10</b>	Relay Fault	Relay contact failure	<p><b>Caution</b>  <b>The STP will continue to run after this fault indication is displayed.</b></p> <ol style="list-style-type: none"> <li>1. Push reset button and hold in for three seconds on the STP-SCIII.</li> <li>2. If the condition is corrected, check for proper operation of system; if operating correctly do not continue to next step. If condition is still present continue to next step.</li> <li>3. Disconnect power at load centers, lock and tag circuit breakers.</li> <li>4. Replace Relay, see "Replacement Parts" section.</li> <li>5. Turn on power to the STP-SCIII unit and verify correct system operation.</li> </ol>
<b>11</b>	L2 Open	L2 Input Leg not connected	<ol style="list-style-type: none"> <li>1. Disconnect power at load center, lock and tag circuit breakers. Remove cover from enclosure.</li> <li>2. Verify that the L2 leg is connected to the terminal labeled L2 on the STP-SCIII. Put cover back on enclosure.</li> <li>3. Re-apply input power. Press reset on the STP-SCIII and verify correct system operation.</li> <li>4. If the problem is not corrected, contact an electrician to correct the problem.</li> </ol>
<b>12</b>	Over Voltage	Voltage Too High (Out of Spec)	<ol style="list-style-type: none"> <li>1. Press and hold push button for three seconds.</li> <li>2. Verify proper system operation.</li> <li>3. Re-calibrate (See Under Voltage 2 flashes section).</li> <li>4. If system is not operating correctly, contact FE Petro Technical Support for assistance.</li> </ol>
<b>13</b>	Voltage Unbalance	<b>Warning Only</b>	<ol style="list-style-type: none"> <li>1. Push reset button and hold in for three seconds.</li> <li>2. If the fault clears, verify proper system operation.</li> <li>3. If the fault does not clear, contact an electrician to troubleshoot the incoming power.</li> </ol>
<b>14</b>	Load Unbalance	<p>Start Capacitor Inadvertently Connected Across 2 Phases/ Faulty PMA / Large Voltage Unbalance</p> <p><b>Warning Only</b></p>	<ol style="list-style-type: none"> <li>1. Push reset button and hold in for three seconds.</li> <li>2. If the fault clears, verify proper system operation.</li> <li>3. If the fault does not clear, turn off power at the load center, lock out and tag the circuit breaker. Remove the cover at the pump junction box. If a capacitor is present, remove the capacitor and connect the junction box wiring per the wiring diagram in this manual. If there is no capacitor present, proceed to the next step.</li> <li>4. With the power still off, measure the resistance of the windings. (See TB004 for the proper values) If the measurements are not within the acceptable limits replace PMA. See "<b>PMA Replacement/Inspection</b>" section in the <b>three flashes section of this manual</b>.</li> <li>5. Apply input power and depress the push button. If the fault clears, verify proper system operation. If the fault does not clear, contact FE Petro technical support for assistance.</li> </ol>

**Contact FE Petro for additional troubleshooting information at 1-800-225-9787.**

## REPLACEMENT PARTS

<i>Item #</i>	<i>Part #</i>	<i>Description</i>	<i>Qty</i>
1	223878102	3-Phase Relay, 240 Volt Coil	1
2	223905901	Logic Board Assembly	1
3	223910902	380-415 Volt Power Board Assembly	1

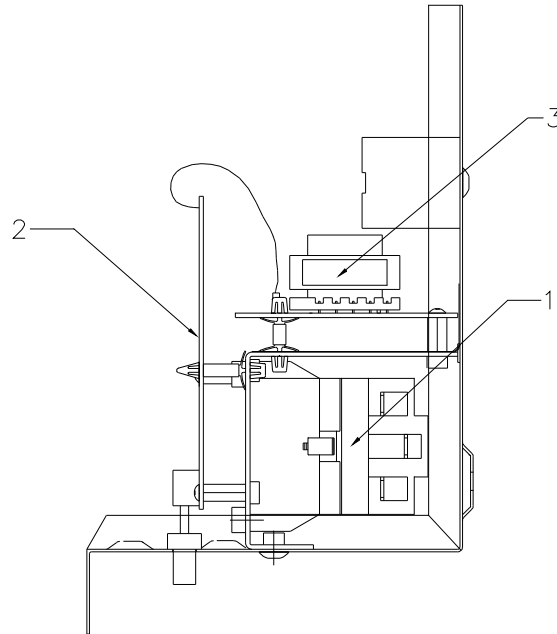

**STP-SCIIC Right Side View**  
(Shown with cover off)



**FE PETRO<sup>®</sup>**

**Franklin Fueling Systems**

3760 Marsh Road • Madison, WI 53718 U.S.A.

Tel: +1 608 838 8786 • Fax: +1 608 838 6433 • [www.franklinfueling.com](http://www.franklinfueling.com)

Tel: USA & Canada 1 800 225 9787 • Tel: Mexico 001 800 738 7610